

Grundeinstellung (Empfehlung)
Basic setting (recommended)

Réglage de base (recommandation)
Configuración básica (Recomendación)

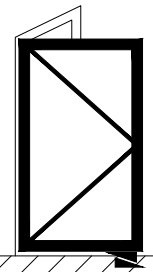
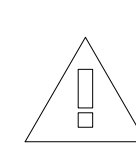
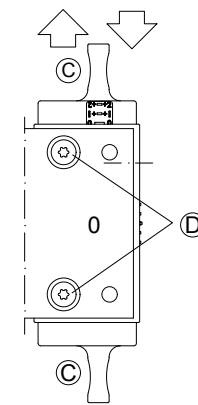
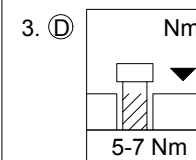
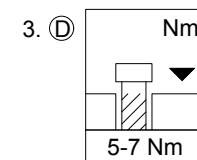
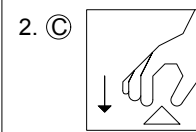
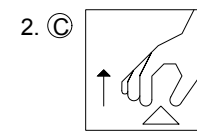
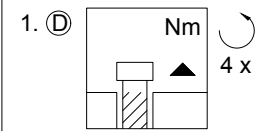
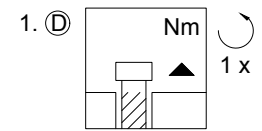
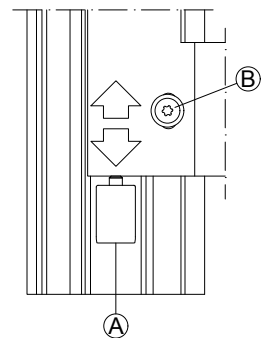
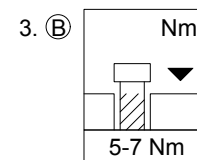
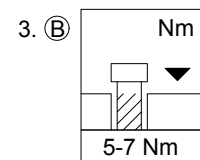
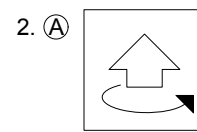
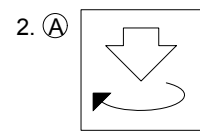
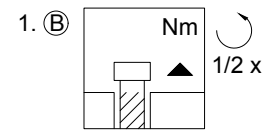
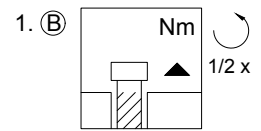
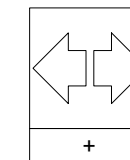
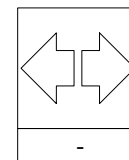
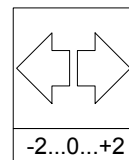
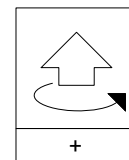
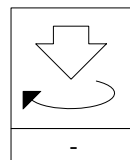
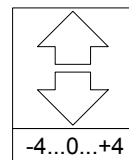
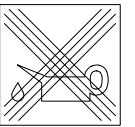
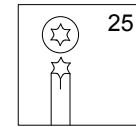
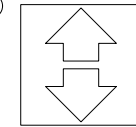
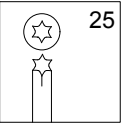
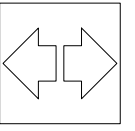
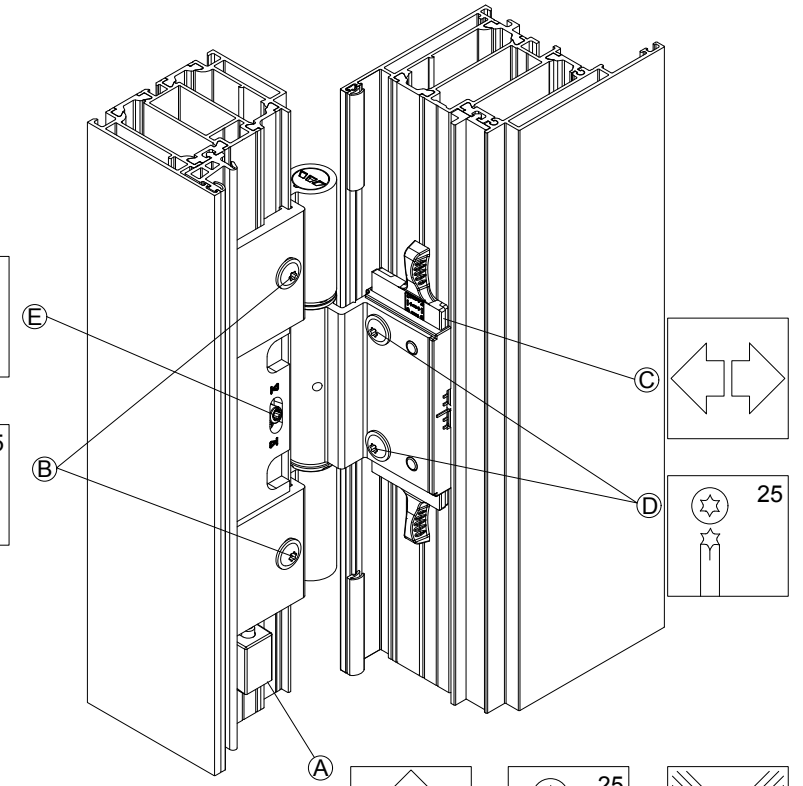
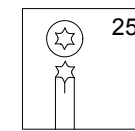
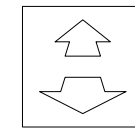
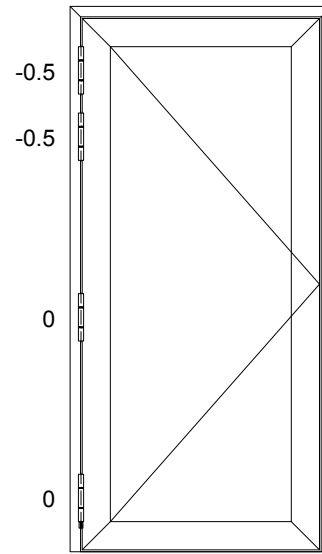
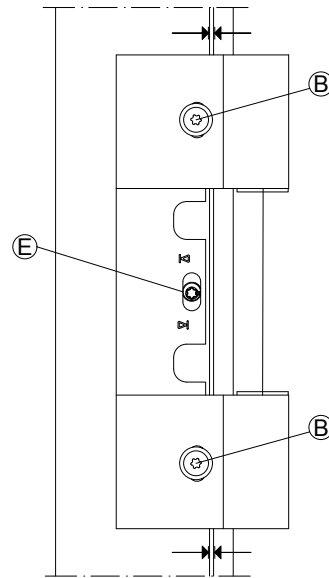
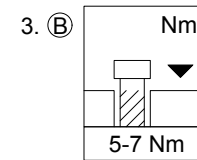
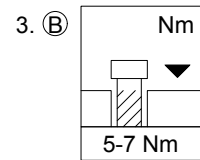
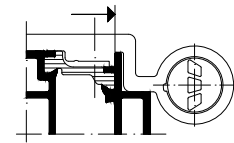
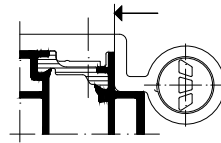
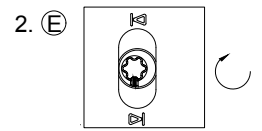
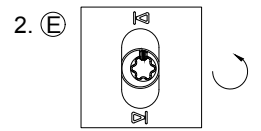
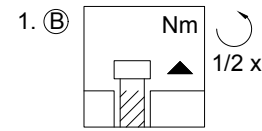
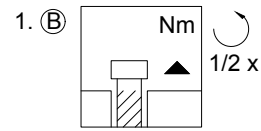

OKFF

Rollentürband entlasten
Relieve pressure on the barrel hinge
Soulager la paumelle cylindrique de porte
Libere la carga de la bisagra cilíndrica de puerta

Rollentürbänder - Bandeneinstellung	K1020878
Barrel hinges - Hinge adjustment	0100
Paumelle cylindrique de porte - Réglage des paumelles	
Bisagras cilíndricas de puerta - Ajustes de la bisagra	Schüco AD UP